



WORLD
PRECISION
INSTRUMENTS

NEW LAB PROGRAM

Save on Lab Supplies • Expert Help • Application Packages



Manual TEER Measurement Package

WPI's EVOM system is popular in the research community, and it is commonly used for the evaluation of mammalian cellular health by measuring transepithelial/transendothelial electrical resistance (TEER or TER) of cellular layers. EVOM3 has advanced features for performing experiments easily. With the new touchscreen display you can now store data as Microsoft® Excel files on a USB flash drive. Just remove the flash drive with all your recorded data from the EVOM3 and plug it into a computer to access and plot your data. It is as simple as it sounds.

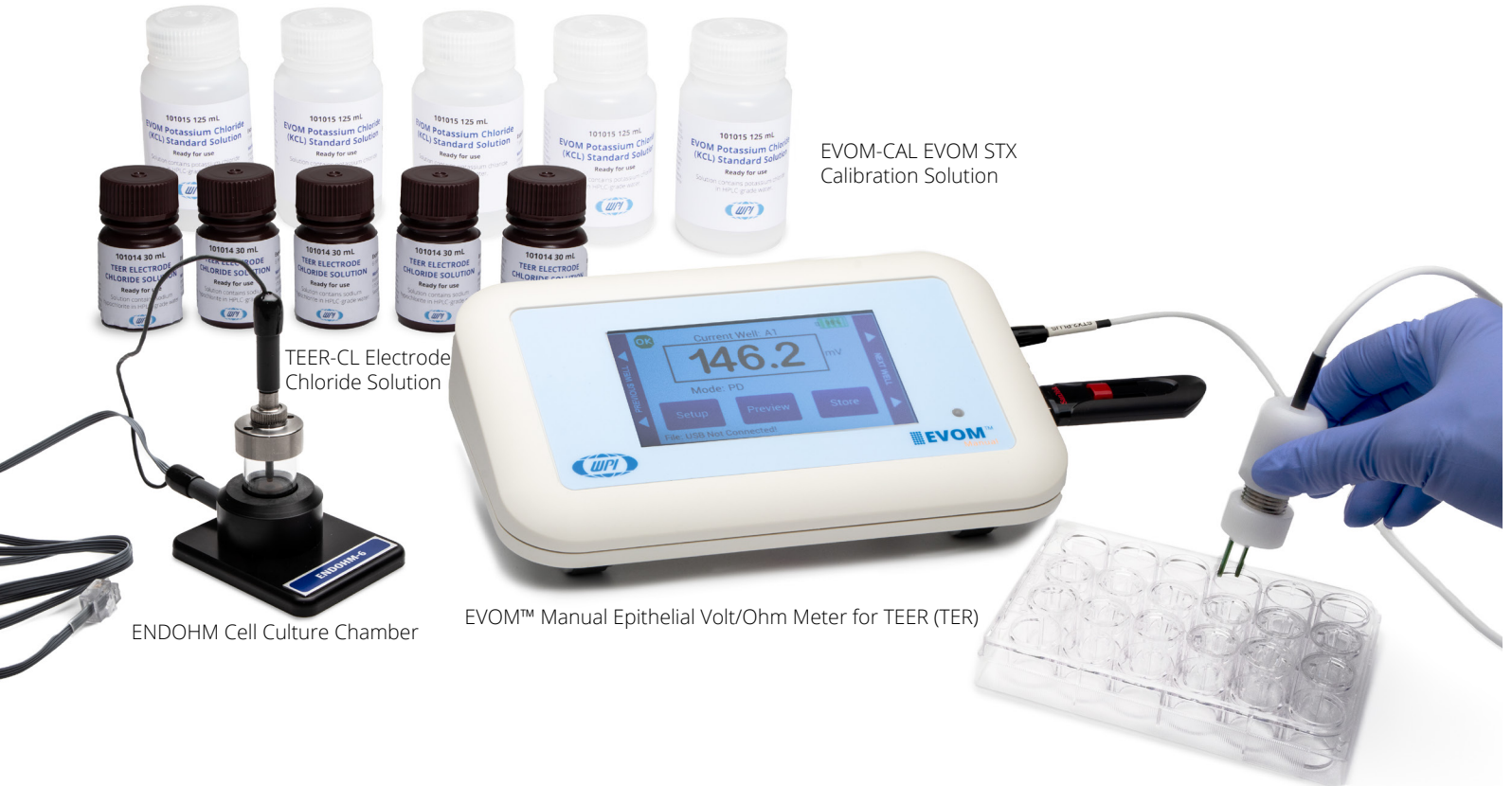

EVOM-CAL EVOM STX Calibration Solution

TEER-CL Electrode Chloride Solution

ENDOHM Cell Culture Chamber

EVOM™ Manual Epithelial Volt/Ohm Meter for TEER (TER)

MANUAL TEER MEASUREMENT SYSTEM

Part Number	Description
EVM-MT-03-01	EVOM™ Manual High Throughput Screening System
TEER-CL	TEER Electrode Chloride Solution
EVOM-CAL	EVOM STX Calibration Solution
EVM-EL-03-01-01	Choice of EndOhm Cell Culture Cup Chambers for use with the EVOM3
EVM-EL-03-03-01	STX4 EVOM™ Electrode with Removable Blades for TEER in 6 mm Inserts
EVM-EL-03-02-01	STX HTS EVOM™ Electrode for TEER in Corning 96
EVM-EL-03-02-02	STX HTS EVOM™ Electrode for TEER in Millipore 96
EVM-EL-03-02-03	STX HTS EVOM™ Electrode for TEER in Corning Biocoat/ Falcon 24
EVM-EL-03-02-04	STX HTS EVOM™ Electrode for TEER in Corning Costar 24
CCI96-PET-0.4	PermaCell Cell Culture Insert Plates, 96-well, PET, 0.4 µm

Cover Your Assay Protection Plan

WPI recognizes how valuable your research is and strives to ensure that your research continues with minimal disruption when unexpected events occur. In an effort to best support researchers and minimize equipment and personnel downtime, we are pleased to introduce our **Cover Your Assay Protection Plan**. For a limited time, EVOM™ Manual System purchasers have the opportunity to be upgraded to Premium Warranty coverage on the EVOM™ Manual and WPI STX HTS EVOM™ Electrode when you commit to purchase as few as 50 PermaCell insert plates per year. This plan coverage exceeds the EVOM™ Manual standard manufacturers warranty and includes accidental damage to your equipment. If our Precision Care Center is unable to repair your EVOM™ Manual unit within 5 days, a new unit will be shipped out to you overnight (up to one replacement per year), pending availability. Our Cover Your Assay Protection Plan also extends the WPI STX HTS EVOM™ Electrode warranty from 30 days to include up to two electrode replacements per year. This plan covers:

Repairs of
Accidental
Damage

Live Technical
Support

Annual
Calibration
and
Maintenance

Software
Upgrades
when
available

EVOM™
Manual and
STX HTS
Electrode

For details, see: www.wpiinc.com/extended-warranty.

RETURN POLICY

- When a full system is purchased, only the full system may be returned.
- Once insert plates are opened, plates cannot be returned for a refund. If a system is returned, the regular selling price of the plates will be deducted from the system price for a partial return credit.
- The CYA Protection Plan guarantee is void if the minimum insert plate purchase has not been made.
- Warranty may be reinstated if the purchase quantity is made current.

*WPI is an authorized distributor of MatTek PermaCell insert plates.



Microinjection Application Packages

Our customizable Microinjection Application Packages has everything you need to get started. **We can help you customize your system with many options and accessories.**

The basic system includes:

- Microinjection pump like the PV850 Microinjector
- LED lighted microscope base with a PZMIII Stereo Microscope and an articulating mirror
- Micromanipulator

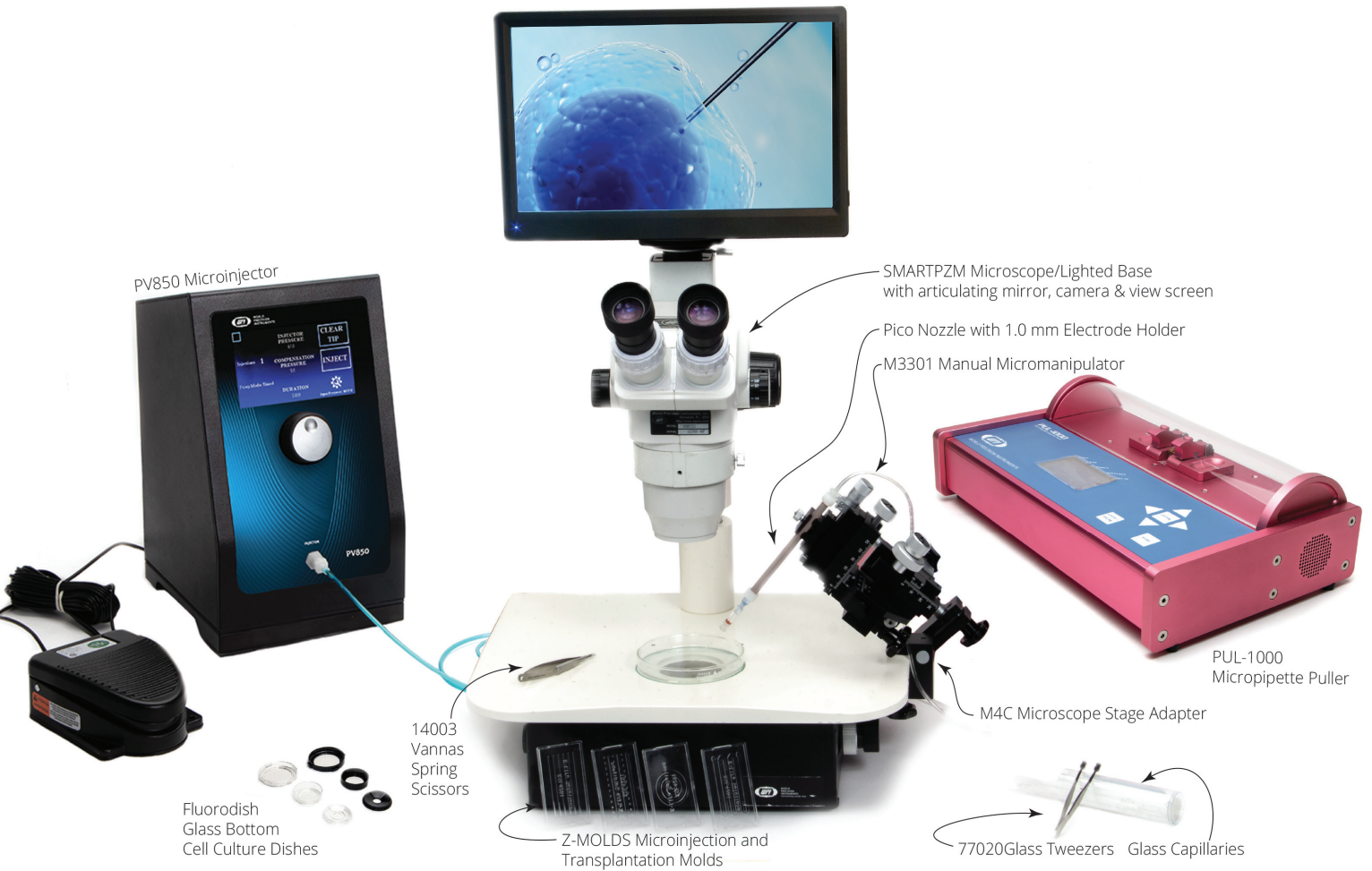

WPI offers a variety of pumps along with special syringes, stereotaxic frames, glass capillaries and needles. The setup you choose depends on the size of your microinjection aliquots, the volume to be injected and the size of needle or glass tip you choose.

Whether you are working with *Danio rerio* (zebrafish), *Xenopus*, *Drosophila* or *Caenorhabditis elegans*, we can help you customize a microinjection system for your application.

ADVANCED ZEBRAFISH MICROINJECTION SYSTEM WITH PULLER

Part Number	Description
uPump	Microinjector with External Pressure Source
SMARTPZM	Teaching Microscope System
M4C	Microscope Stage Adapter
M3301-R or -L	Manual Manipulator, Right or Left Hand
PUL-1000	Microelectrode Puller
Z-MOLDS	Zebrafish Microinjection and Transplantation Molds
77020	Glass Handling Forceps, Straight
504507	WPI Swiss Tweezers, Acid-Resistant/Anti-Magnetic, #5
14003	Vannas Scissors, 8 cm (3.5"), Straight, 5 mm Blades



STANDARD SYSTEM WITH PULLER

Part Number	Description
uPump	Microinjector with External Pressure Source
PZMIII-MI	Stereo Microscope with LED Illuminated Base & Articulating Mirror
M4C	Microscope Stage Adapter
M3301-R or -L	Manual Manipulator, Right or Left Hand
PUL-1000	Microelectrode Puller
Z-MOLDS	Zebrafish Microinjection and Transplantation Molds
77020	Glass Handling Forceps, Straight
504507	WPI Swiss Tweezers, Acid-Resistant/Anti-Magnetic, #5
14003	Vannas Scissors, 8 cm (3.5"), Straight, 5 mm Blades



BASIC SYSTEM WITHOUT PULLER

Part Number	Description
uPump	Microinjector with External Pressure Source
PZMIII-MI	Stereo Microscope with LED Illuminated Base & Articulating Mirror
M4C	Microscope Stage Adapter
M3301-R or -L	Manual Manipulator, Right or Left Hand
Z-MOLDS	Zebrafish Microinjection and Transplantation Molds
77020	Glass Handling Forceps, Straight
504507	WPI Swiss Tweezers, Acid-Resistant/Anti-Magnetic, #5
14003	Vannas Scissors, 8 cm (3.5"), Straight, 5 mm Blades



NANOLITER MICROINJECTION SYSTEM

Our customizable Nanoliter Microinjection System has everything you need to get started. **We can help you customize your system with many options and accessories.**

The basic system includes:

- Nanoliter 2020 Microinjection pump nanoliter injections
- LED lighted microscope base with a PZMIII Stereo Microscope and an articulating mirror
- Micromanipulator
- Many accessories

SMARTPZM Microscope/
Lighted Base with articulating
mirror, camera & view screen

M10 Magnetic Stand
5052 Base (hidden
under backdrop)

KITE Manual Micromanipulator

NANLITER2020 Injector with
SMARTouch Controller

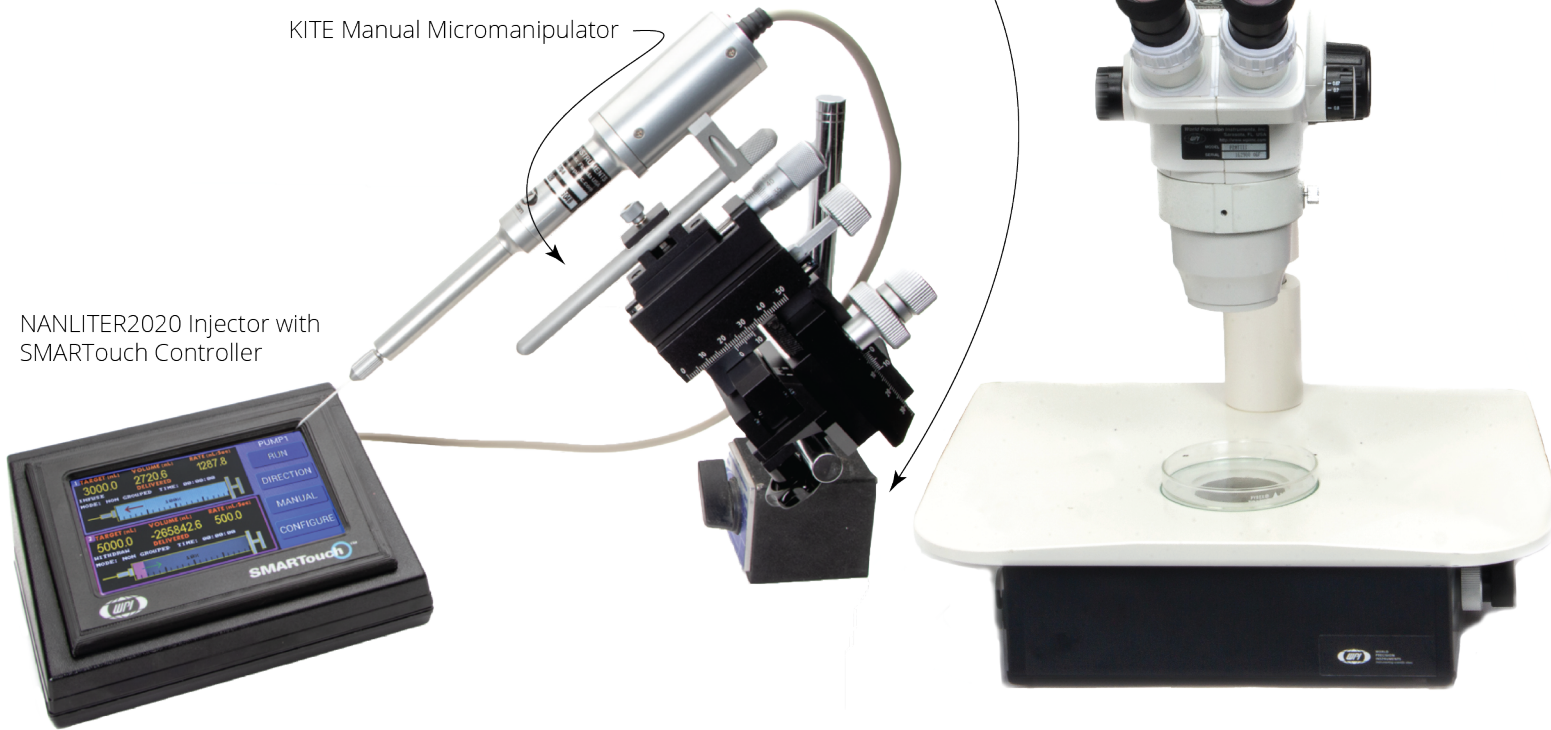

Part Number	Description
NANOLITER2020	Nanoliter 2020 Injection System
SMARTPZM	Stereo Microscope with LED Illuminated Base, Articulating Mirror, Camera & View Screen
KITE	Manual Manipulator, Right or Left Hand
M10	M10 Magnetic Stand
504949	Fire Polished Glass Capillaries, 3.5", pkg. of 300
13142	Foot Switch for the SMARTouch Controller
5052	10 Lb. Base Plate

New Lab Program Application Packages

All packages are customizable
*Discount only valid on purchases of complete packages.

Neuroscience Application Packages

Our customizable Neuroscience Application Packages have everything you need to get started. **We can help you customize your system with many options and accessories.** We offer both stereotaxic injection packages and a neuroscience recording package for making extracellular recordings.

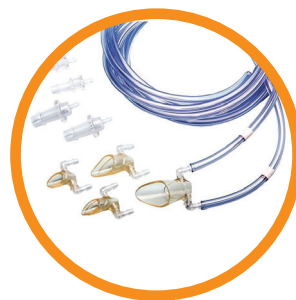
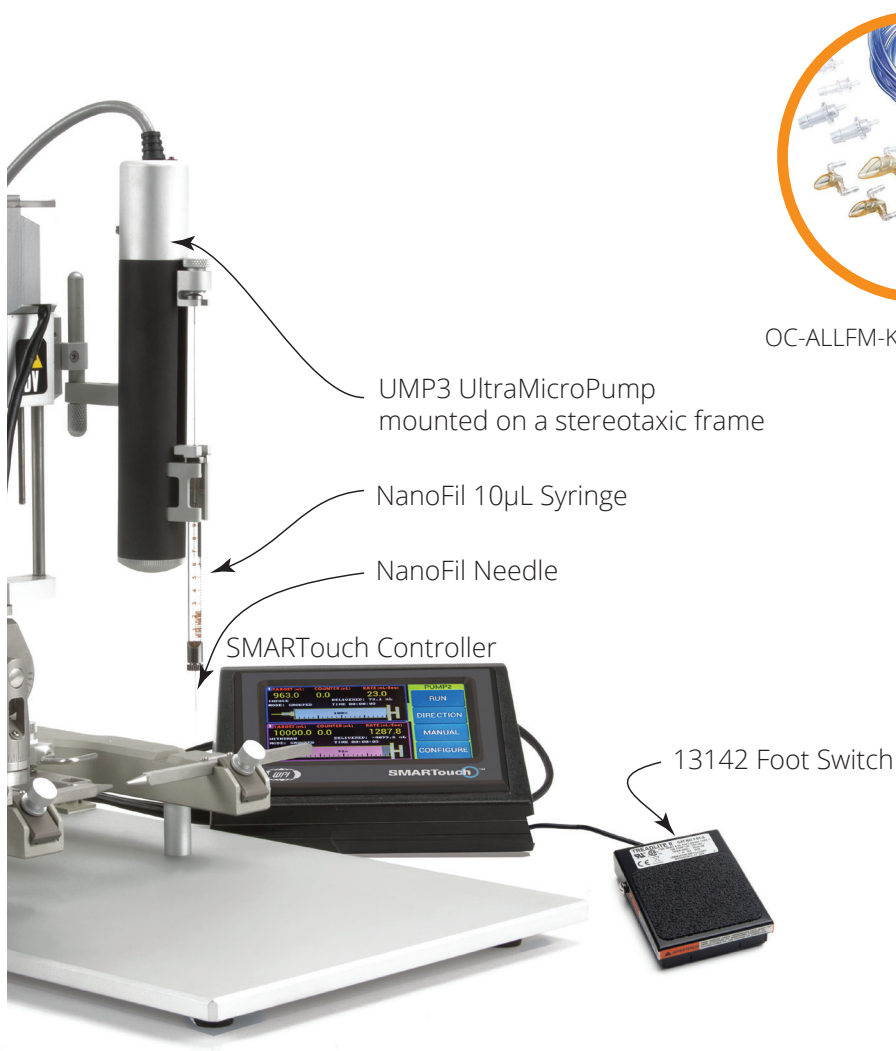

OC-ALLFM-KIT Face Mask Kit



EZ-B800 Anesthesia System



505351 Rat Digital Frame



505200 Standard Mouse & Rat Frame



503598 OmniDrill

RAT STEREOTAXIC INJECTIONS SYSTEM

Part Number	Description
505351	Rat Digital Stereotaxic Frame
UMP3T-1	Microinjection Syringe Pump, one Pump and SMARTouch Controller
13142	Foot Switch for SMARTouch Controller
NANOFIL	Sub-Microliter Injection Syringe, 10 μ L
NF33-36BV or BL	NanoFil Needles, Assortment Kit 33g-36g, Beveled
503598	OmniDrill 35 Micro Drill
EZ-B800	EZ Basic Anesthesia System
OC-ALLFM-KIT	Rodent Facemask Kit for Anesthesia (Small, Medium, Large, Extra Large)

MOUSE/MICE STEREOTAXIC INJECTIONS SYSTEM

Part Number	Description
505200	Standard Mouse & Rat Stereotaxic Frame
UMP3T-1	Microinjection Syringe Pump, one Pump and SMARTouch Controller
13142	Foot Switch for SMARTouch Controller
NANOFIL	Sub-Microliter Injection Syringe, 10 μ L
NF33-36BV or BL	NanoFil Needles, Assortment Kit 33g-36g, Beveled
503598	OmniDrill 35 Micro Drill
EZ-B800	EZ Basic Anesthesia System
OC-ALLFM-KIT	Rodent Facemask Kit for Anesthesia (Small, Medium, Large, Extra Large)

UPGRADE ANY STEREOTAXIC INJECTION SYSTEM

Add-ons are sold separately.

Part Number	Description
UMP3T-1-EX1	UMP3T-1 Extended Warranty, 1 Year
UMP3T-1-EX2	UMP3T-1 Extended Warranty, 2 Year
505375	Temperature Control Box with Cable
505377	Rectal Temperature Probe



NEUROSCIENCE RECORDING SYSTEM (EXTRACELLULAR RECORDING)

A typical application for metal electrodes would require a system like the one shown below. This system shows a differential configuration with an EP1 silver/silver chloride electrode pellet. The EP1 is suitable for use in a mouse cranial application. A sealed RC1 Ag/AgCl electrode pellet could be wired to the amplifier cable in place of the EP1, for another differential configuration.

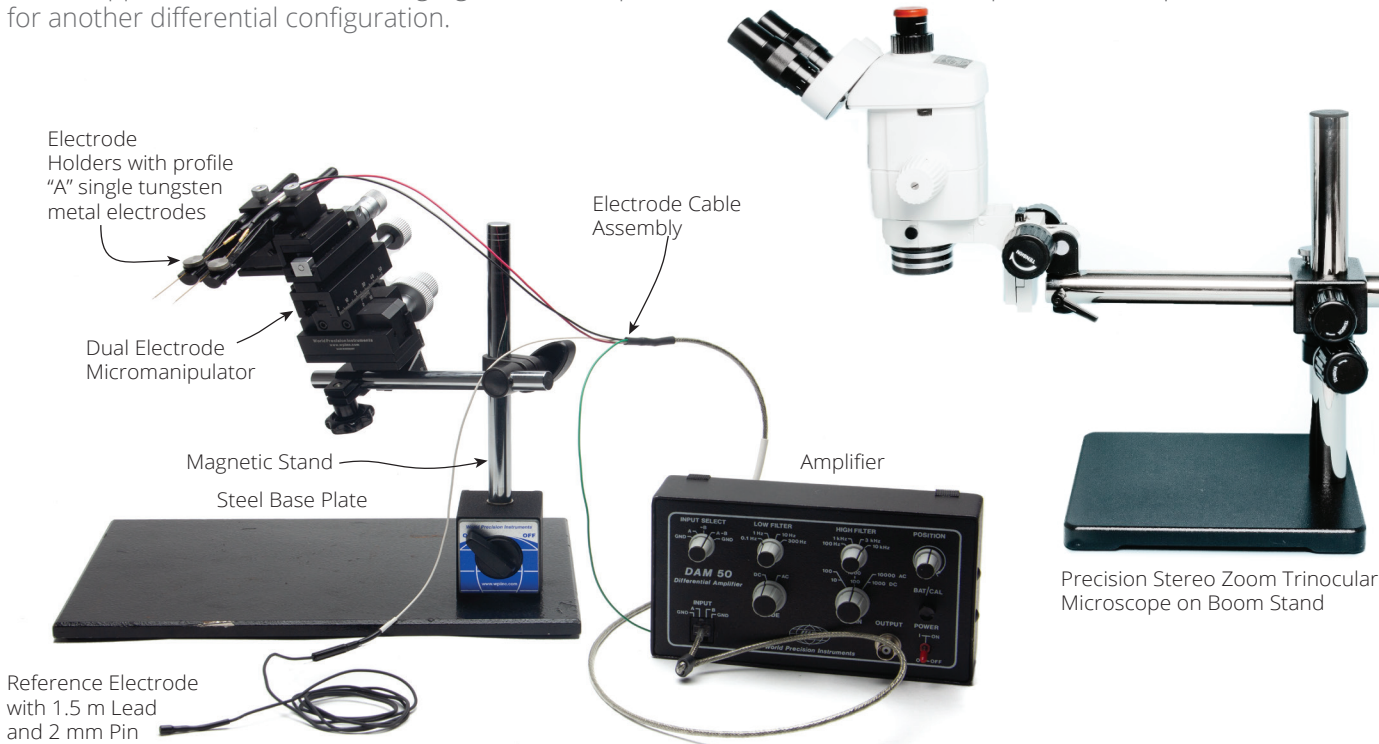

Part Number	Description
DAM50	Extracellular Amplifier
MD4R	Dual Tool Holder Micromanipulator
PZMTIV-BS	Precision Stereo Zoom Trinocular Microscope on a Boom Stand
M3301EH	Replacement Electrode Holder
M10	Magnetic Stand
5052	10 Lb. Steel Base Plate
3517	2 Optional Shielded Modular Cable for DAM50 Bioamplifier
5470	0.031" Jack, 28 ga. Wire, 12", pkg. of 4

UPGRADE NEUROSCIENCE RECORDING SYSTEM

Add-ons are sold separately.

Part Number	Description
SYS-DAM50-EX1	DAM50 Extended Warranty, 1 Year
SYS-DAM50-EX2	DAM50 Extended Warranty, 2 Year

The following bandwidth charts for the DAM50 show the response of the amplifier when various filters and gains are used.

GAINS: This chart shows the standard 3dB frequency cutoff at maximum filter band pass.

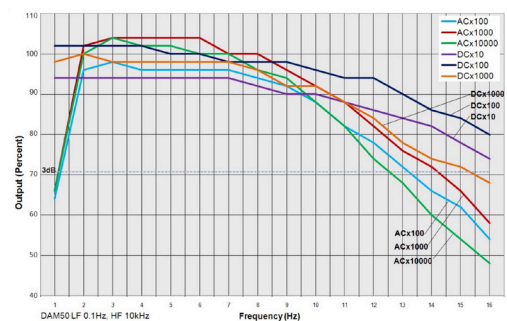

FILTERS: Various low pass and high pass filters were applied at the AC x1000 gain setting to show the bandwidth of and actual DAM50 amplifier.

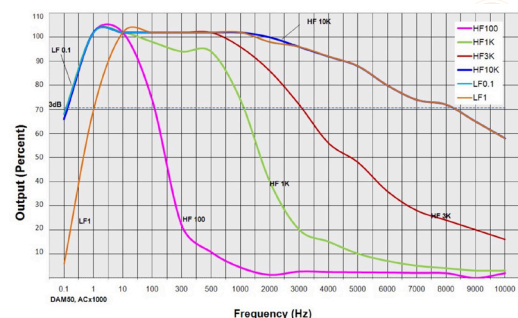

Ophthalmology Application Package

Our customizable Ophthalmology Application Package has everything you need to get started. These kits are specially designed for eye research for retinal pigment epithelium (RPE) and intraocular (IO) injections, in addition to brain injection in mice. They are used exclusively with a NanoFil™ syringe and UMP3 to achieve accurate and repeatable oil-free injections down to sub-microliter ranges. **We can help you customize your system with many options and accessories.**



Benefits

- No oil back filling necessary
- Four needle sizes included in the kit

Applications

- Retinal pigment epithelium injection
- Mouse brain injection
- Intravitreal Injection (with RPE-KIT)
- Intraocular Injection (with IO-KIT)

COMPLETE RETINAL INJECTIONS SYSTEM

Part Number	Description
UMP3T-1	Microinjection Syringe Pump, one Pump and SMARTouch Controller
13142	Foot Switch for SMARTouch Controller
IO-KIT or RPE-KIT	Intraocular Injection Kit or Retinal Pigment Epithelial Injection Kit
503207	FrameWorks V-Base Kit - Small
NANOFIL	Sub-Microliter Injection Syringe, 10 µL

Nanofil Needle Dimensions

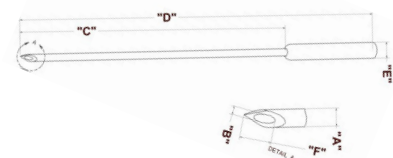

UPGRADE YOUR SYSTEM

Add-ons are sold separately.

Part Number	Description
UMP3T-1-EX1	UMP3T-1 Extended Warranty, 1 Year
UMP3T-1-EX2	UMP3T-1 Extended Warranty, 2 Year

Small Animal Surgery Support Package

Expensive research animals require specialized anesthesia and surgical equipment that is designed for their physiological needs. WPI offers a broad range of laboratory equipment and research products designed specifically for small animal physiology. Let us help you assemble a package with stereotaxic equipment, an anesthesia system with animal temperature control and a blood pressure monitoring system. We also offer testing equipment for pre-clinical trials involving mechanical, thermal and chemical stimuli with mice and rats to perform a variety drug efficacy studies.



Digital Stereotaxic Frame

Blood Pressure System



Basic Anesthesia System



Mouse Dissecting Kit



Animal Temperature Controller
Heating Plate
Mouse Rectal Probe

SMALL ANIMAL SURGERY SYSTEM

Part Number	Description
505371	WPI Premium Digital Rat Stereotaxic Frame
EZ-B800	Basic Animal Anesthesia System
SYS-BP1	Blood Pressure Monitoring System
BLPR2	Blood Pressure Transducer and Cable
ATC2000	Animal Temperature Controller
61840	15x4 cm Heating Plate for the ATC2000
RET-2	Mouse Rectal Probe, Ball Tip
MOUSEKIT	Mouse Dissecting Kit with Portfolio

ATC2000 Accessories

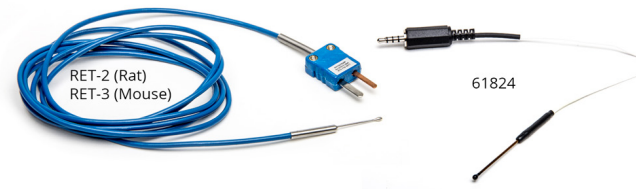

RET-2 (Rat)
RET-3 (Mouse)

61824



61840 (15x4 cm)
61830 (15x10 cm)
61800 (15x25 cm)

Save on Lab Supplies/Accessories for Every New Lab

Take advantage of steep discounts on surgical adhesives and lab accessories. Surgical instrument kits are also discounted for your new lab. Visit www.wpiinc.com/newlab to complete the New Lab Registration form and get started. A quote is required to get these New Lab discounts.

ADHESIVES

Buy in bulk and save on these popular adhesives. The prices below reflect the purchase of the minimum bulk quantity.

Part Number	Description	Bulk Qty
503763	GLUture Topical Tissue Adhesive	5
VETBOND	Butyl Cyanoacrylate, Low Toxicity Adhesive	5
KWIK-SIL	Low Toxicity Silicone Adhesive	10
KWIK-CAST	Low Viscosity Silicone Sealant	10



LIMITED REUSE BIOPSY PUNCHES

Our reusable biopsy punches are multi-purpose sampling tools designed with a retractable cutting cannula. They are easy to operate, efficient, safe, fast and precise. Our punches consists of a razor sharp stainless steel cutting tip. They are designed to cut, retrieve and store the cored samples from a source materials. They range in size from 0.35 – 8 mm. Punches are sold sterile and individually wrapped. Order in bulk (50 or 100 of a single size) and save up to 35% off the list price.

Part Number	Description	Bulk Qty
504528-504535,	Limited Reuse Biopsy Punches	50
504646-504651	Limited Reuse Biopsy Punches	100



EAR TAGS

Save on popular ear tags for small animals. Made of 0.46 mm Monel alloy, they are 2.36 mm wide. Each package contains 100 sequentially numbered tags, ranging from 000 to 999, depending on the part numbers you choose. Or order in batches of 1000 to get numbers up to 4999.

Part Number	Description
501866-501875, 501893	Ear Tags for use with the 503292 applicator, pkg. of 100

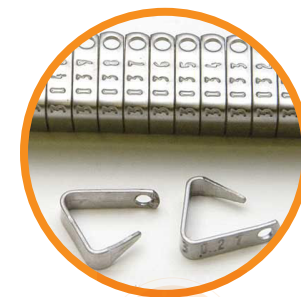

SURGICAL INSTRUMENT KITS

You have many options for surgical instrument kits, from economical student quality to German instrument kits specifically designed for the surgeries in your new lab. Take advantage of these discounts.

Part Number	Description
504167	Student Dissection Kit
501336	Student Veterinary Kit
504165	Student Botanical Kit
504196	Vet Tech Surgical Instrument ID Kit
MOUSEKIT	Mouse Dissecting Kit
KIT-EXOTIC	Exotic Animal Surgical Kit
501315	Micro-Surgical Kit
WPZ00018	Zebrafish Kit I
WPZ00218	Zebrafish Kit II



504167 - Student Dissection Kit



504196 - Vet Tech Surgical Instrument ID Kit



501336 - Student Veterinary Kit



504165 - Student Botanical Kit



KIT-EXOTIC - Exotic Animal Surgical Kit

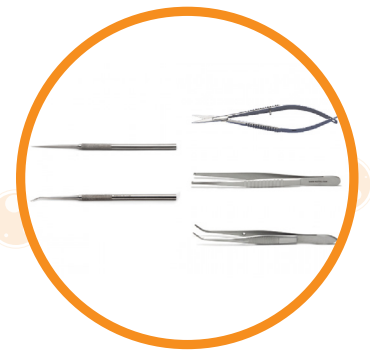

WPZ00218 - Zebrafish Kit II



MOUSEKIT - Mouse Dissecting Kit



501315 - Micro-Surgical Kit

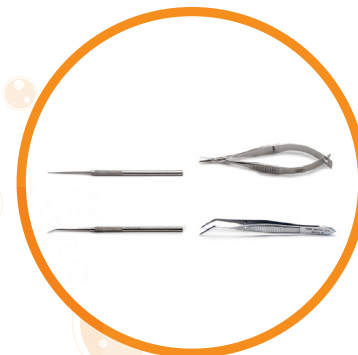

WPZ00018 - Zebrafish Kit I

ADHESIVES

The adhesive you select will be heavily influenced by your application. Use the table below to help you choose the best glue for your life science research project.



SILICONE (Adhesive/Sealants/Primers) Good moisture resistance and elasticity. Low toxicity.			
Part No.	Description	Curing Time	Useful Applications and Characteristics
1571	Room temperature vulcanizing (RTV) adhesive. Acyloxy/moisture cure system. Acetic acid is a curing by-product.	24hrs@25C	Has the best adhesion property in this silicone family. Will bond to many materials.
7128	RTV sealant. Alkoxy/Moisture cure system. Methanol is a curing by-product.	72hrs@25C	Good for bonding or sealing electronics circuits (metal).
SYLG184	Sylgard, Two parts, vinyl/platinum cure sealant. Hydrogen is a curing by-product. Very low toxicity.	24hrs@25C, 15 min.@150C	Coating patch clamp electrodes, cell culture dish, making dissection pads.
Kwik-Sil	Two part, adhesive. Vinyl/platinum system, Hydrogen is a curing by-product. Very low toxicity.	< 5 min@25C	Live tissue and nerve studies. Medium strength adhesion.
Kwik-Cast	Two part sealant. Vinyl/platinum cure system. Hydrogen is a curing by-product. Very low toxicity.	< 5 min@25C	Sealant for live tissues. Embedding peripheral nerves with electrodes.
6820	Primer for silicone.	N/A	Enhances adhesion of silicone adhesives for difficult to bond plastic surfaces.

CYANOACRYLATE Forms an instantaneous bonding.			
7341	Ethyl Cyanoacrylate, low viscosity 90-120 cps	<10 seconds	Mounting rat/mouse brain slices. Ideal for relatively small gaps and smooth surfaces. Bonds plastic, metals and rubber. Package of 10 vials, each approximately 1.5 mL.
7342	Ethyl Cyanoacrylate, high viscosity 1100-1600 cps	<30 seconds	Use on brain slice. Ideal for larger gaps, allows slightly longer bonding time. Bonds plastic, metals and rubber. Package of 10 vials, each approximately 1.5 mL.
Vetbond	Butyl Cyanoacrylate, low toxicity	<10 seconds	Bonds tissues, alternative to suture, helps small wound healing. Antimicrobial effect. Used in forensic science.
503763	Octyl Cyanoacrylate, low toxicity	<15 seconds	Suitable for surface wound bonding, protection, holding a sensor or other device on the tissue.

EPOXIES Form strong bonding. Used in wire bonding applications.			
4898	Silver filled conductive Epoxy	12 hrs@50C; 5 min @150C	Connecting conductors that can't be soldered. Constructing or connecting Ag/AgCl pellets.
7335	Carbon filled conductive Epoxy	48 hrs@25C; 5 min @150C	Constructing carbon electrode.
4886	High performance structural epoxy	12 hrs@25C.	Forms a strong and slightly flexible bond on plastic, metal, and glass. Bonds some low surface.
503763	Octyl Cyanoacrylate, Low toxicity	<15 seconds	Suitable for surface wound bonding, protection, holding a sensor or other device on the tissue.

HOT MELT (EVA) Easy to use for bonding, needs large gap filling.			
13316	Mini Glue Gun with glue sticks	As soon as it cools down	Bonds wood, glass, metals, and many plastics.

GLASS CAPILLARIES

- Glass orders ship within 48 hours.
- Standard glass is available with or without a fused filament to the inner wall. Filaments aid in the capillary action that allows electrodes to be filled.
- Capillary glass with multiple barrels is available in two, three, five, and seven-barrel configurations.
- For finer tips and shorter tapers, a range of single barrel thin-wall glass is available.
- Special configurations such as septum theta and piggyback glass capillaries are also available.



Single Barrel Standard Borosilicate Glass

Length ± 1 mm	OD(mm) ± 0.1 mm	ID(mm) ± 0.1 mm	Filament	Fire-Polished	Quantity	Item
3 in. (76 mm)	1.0	0.58	✓		500	1B100F-3
3 in. (76 mm)	1.0	0.58			500	1B100-3
3 in. (76 mm)	1.2	0.68	✓		350	1B120F-3
3 in. (76 mm)	1.2	0.68			350	1B120-3
3 in. (76 mm)	1.5	0.84	✓		225	1B150F-3
3 in. (76 mm)	1.5	0.84		✓	300	1B150-3
4 in. (100 mm)	1.0	0.58	✓	✓	500	1B100F-4
4 in. (100 mm)	1.0	0.58		✓	500	1B100-4
4 in. (100 mm)	1.2	0.68	✓	✓	400	1B120F-4
4 in. (100 mm)	1.2	0.68		✓	350	1B120-4
4 in. (100 mm)	1.5	0.84	✓	✓	300	1B150F-4
4 in. (100 mm)	1.5	0.84		✓	300	1B150-4
4 in. (100 mm)	2.0	1.12	✓		125	1B200F-4
4 in. (100 mm)	2.0	1.12		✓	200	1B200-4
6 in. (152 mm)	1.0	0.58	✓		500	1B100F-6
6 in. (152 mm)	1.0	0.58			500	1B100-6
6 in. (152 mm)	1.2	0.68	✓		350	1B120F-6
6 in. (152 mm)	1.2	0.68			350	1B120-6
6 in. (152 mm)	1.5	0.84	✓		225	1B150F-6
6 in. (152 mm)	1.5	0.84			225	1B150-6
6 in. (152 mm)	2.0	1.12	✓		125	1B200F-6
6 in. (152 mm)	2.0	1.12			125	1B200-6

Thin-Wall Single Barrel Standard

Length ± 1 mm	OD(mm)	ID(mm)	Filament	Fire-Polished	Quantity	Item
3 in. (76 mm)	1.0	0.75	✓		500	TW100F-3
3 in. (76 mm)	1.0	0.75			500	TW100-3
3 in. (76 mm)	1.2	0.90	✓	✓	400	TW120F-3
3 in. (76 mm)	1.2	0.90			350	TW120-3
3 in. (76 mm)	1.5	1.12	✓		225	TW150F-3
3 in. (76 mm)	1.5	1.12		✓	300	TW150-3
4 in. (100 mm)	1.0	0.75	✓		500	TW100F-4
4 in. (100 mm)	1.0	0.75		✓	500	TW100-4
4 in. (100 mm)	1.2	0.90	✓		350	TW120F-4
4 in. (100 mm)	1.2	0.90			350	TW120-4
4 in. (100 mm)	1.5	1.12	✓		225	TW150F-4
4 in. (100 mm)	1.5	1.12		✓	300	TW150-4
6 in. (152 mm)	1.0	0.75	✓		500	TW100F-6
6 in. (152 mm)	1.0	0.75		✓	500	TW100-6
6 in. (152 mm)	1.2	0.90	✓	✓	400	TW120F-6
6 in. (152 mm)	1.2	0.90			350	TW120-6
6 in. (152 mm)	1.5	1.12	✓		225	TW150F-6
6 in. (152 mm)	1.5	1.12		✓	300	TW150-6

Single barrel glass is Kimble N51A. All thin wall glass is Schott Duran 8330.

Item	Description
77020	Glass Handling Forceps

Multi-Barrel Borosilicate Glass Tubing with Filaments

Length ± 1 mm	Description	OD/ID (per barrel) ± 0.1 mm	Filament	Qty	Item
4" (102mm)	2-Barrel	1.5/0.84 mm	✓	100	2B150F-4
4" (102mm)	3-Barrel	1.2/0.68 mm	✓	100	3B120F-4
4" (102mm)	5-Barrel	1.2/0.68 mm	✓	65	5B120F-4
4" (102mm)	7-Barrel	1.0/0.58 mm	✓	60	7B100F-4
4" (102mm)	7-Barrel	1.2/0.68 mm	✓	75	7B120F-4
6" (152mm)	2-Barrel	1.5/0.84 mm	✓	100	2B150F-6
6" (152mm)	3-Barrel	1.2/0.68 mm	✓	100	3B120F-6
6" (152mm)	5-Barrel	1.2/0.68 mm	✓	65	5B120F-6
6" (152mm)	7-Barrel	1.0/0.58 mm	✓	60	7B100F-6

Borosilicate Glass Rod

Description	OD (mm)	Length	Qty	Item
Glass Rod	1.0	4 in. (102mm)	500	GR100-4
Glass Rod	1.0	6 in. (152mm)	500	GR100-6

Patch Clamp Capillary Glass

Catalog#	Glass Type	OD/ID (mm)	Dielectric Constant	Softening Point °C	QTY
PG52151-4	#8250	1.5/1.0	4.9	720°	100
PG52165-4	#8250	1.65/1.1	4.9	720°	100
PG10150-4	#0010	1.5/0.75	6.7	625°	100
PG10165-4	#0010	1.65/1.1	6.7	625°	100

Special Configuration Borosilicate Glass Tubing

Description	OD/ID (mm) ± 0.1 mm	Length ± 1 mm	Qty	Item
Septum Theta	1.5/1.02	6 in. (152 mm)	100	TST150-6
Piggyback	1.51/0.84 0.75/0.35	4 in. (102 mm)	50	PB150F-4
Piggyback	1.51/0.84 0.75/0.35	6 in. (152 mm)	50	PB150F-6

PRE-PULLED MICROPIPETTES

Avoid the expense and hassle of making your own micropipettes. Get consistently sized pre-pulled glass micropipettes for injection of dyes or proteins into cells, oocytes, and a variety of other biomedical laboratory applications. The diameters of the tips (ID) range from 0.1 to 10µm.

DID YOU KNOW?

Silanization waterproofs the glass, allowing it to withstand water when inserted into a cell. This prevents the outside fluid from flowing down the pipette and entering the pipette.

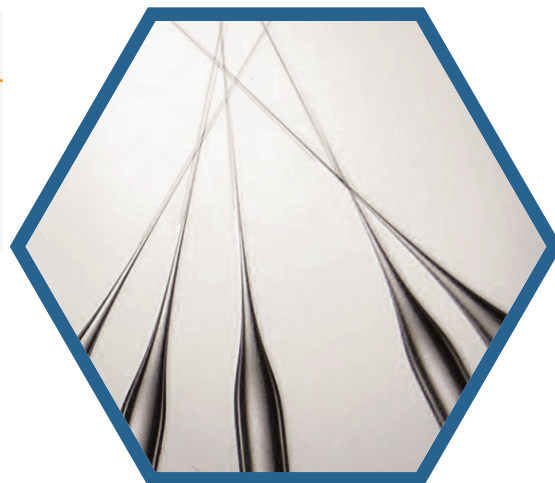
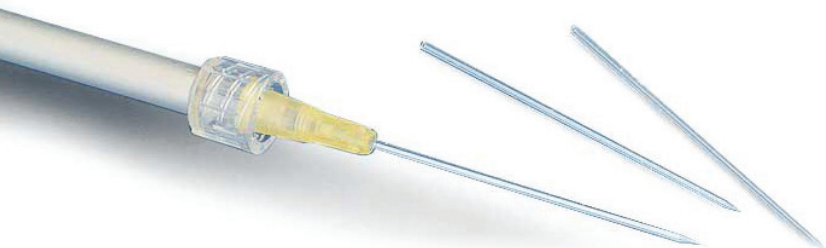

Order Code	Shank	Tip I.D.	Shank Length	Glass O.D.	Filament	Fire Polished
TIP01TW1F	Plain	0.1µm	—	1.0 mm Thin-Wall	Yes	No
TIP02TW1F	Plain	0.2 µm	—	1.0 mm Thin-Wall	Yes	No
TIP03TW1F	Plain	0.3 µm	—	1.0 mm Thin-Wall	Yes	No
TIP04TW1F	Plain	0.4 µm	—	1.0 mm Thin-Wall	Yes	No
TIP05TW1F	Plain	0.5 µm	—	1.0 mm Thin-Wall	Yes	No
TIP1TW1	Plain	1 µm	—	1.0 mm Thin-Wall	No	Yes
TIP2TW1	Plain	2 µm	—	1.0 mm Thin-Wall	No	Yes
TIP5TW1	Plain	5 µm	—	1.0 mm Thin-Wall	No	Yes
TIP10TW1	Plain	10 µm	—	1.0 mm Thin-Wall	No	Yes
TIP10XV119	Plain	10 µm	—	1.14 mm A203XV glass *	No	Yes
TIP30TW1	Plain	30 µm	—	1.0 mm Thin-Wall	No	Yes
TIP01TW1F-L	Luer	0.1µm	—	1.0 mm Thin-Wall	Yes	—

Order Code	Shank	Tip I.D.	Shank Length	Glass O.D.	Filament	Fire Polished
TIP02TW1F-L	Luer	0.2µm	—	1.0 mm Thin-Wall	Yes	—
TIP05TW1F-L	Luer	0.5µm	—	1.0 mm Thin-Wall	Yes	—
TIP1TW1-L	Luer	1µm	—	1.0 mm Thin-Wall	No	—
TIP2TW1-L	Luer	2µm	—	1.0 mm Thin-Wall	No	—
TIP5TW1-L	Luer	5µm	—	1.0 mm Thin-Wall	No	—
TIP10TW1-L	Luer	10µm	—	1.0 mm Thin-Wall	No	—
TIP30TW1-L	Luer	30µm	—	1.0 mm Thin-Wall	No	—
TIP5TW1LS01	Luer/ Silanized	5µm	1 inch	1.0 mm Thin-Wall	No	—
TIP5TW1LS02	Luer/ Silanized	5µm	2 inch	1.0 mm Thin-Wall	No	—
TIP10TW1LS01	Luer/ Silanized	10µm	1 inch	1.0 mm Thin-Wall	No	—
TIP10TW1LS02	Luer/ Silanized	10µm	2 inch	1.0 mm Thin-Wall	No	—
TIP30TW1LS01	Luer/ Silanized	30µm	1 inch	1.0 mm Thin-Wall	No	—
TIP30TW1LS02	Luer/ Silanized	30µm	2 inch	1.0 mm Thin-Wall	No	—

MICROPIPETTE HOLDERS AND HALF CELLS

Microelectrode holder-half-cells from WPI connect fluid-filled glass micropipettes to high input impedance amplifiers. Stable potential is provided by an Ag/AgCl pellet (or silver wire) molded into the holder body. Male 2mm pins or female 2mm sockets are used to make electrical connections. The pipette can be positioned either axially or at right angles to the holder.

When WPI microelectrode holders are filled with chloride-containing electrolytes, the electrode potential remains stable. Electrolytes that are appropriate include KCl, NaCl, and CaCl_2 . Holders are provided for standard WPI single glass capillary tubing with outside diameters of 1.0, 1.2, 1.5, and 2.0mm.

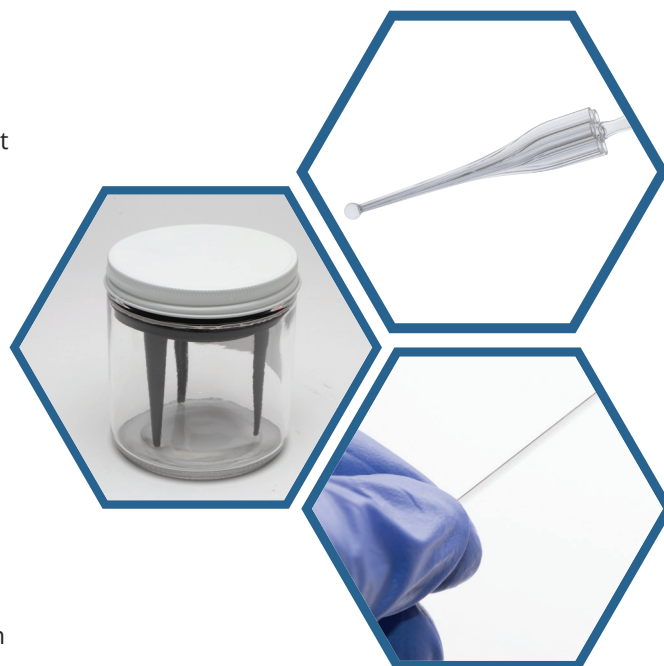

CHOOSING MICROPIPETTE HOLDERS

- Determine the electrical connection needed on the holder. For a 2mm pin connections, choose a 2mm jack holder.
- Determine the electrical connection's required alignment (in-line with the glass pipette or at a right angle to it).
- Will a rubber gasket (for easy insertion/removal of pipette) or screw-cap (secure mounts) hold the glass pipette.
- For the metal/liquid coupling, select a holder with either a silver wire (more durable and easier to use when equipped with a pressure port) or a silver/silver chloride pellet (a more stable, low-noise baseline).
- Only use a holder with a pressure port if you want to pressure inject liquid from the pipette. Choose a 2.0mm O.D. or a standard "syringe-style" luer port, which simplifies assembly and disassembly.
- Some non-WPI pre-amplifiers and headstages are not compatible with micromanipulators and will require a holder with a rod to easily mounted on a micromanipulator.
- Specify the O.D. of the glass you will be using when you order.



SELECT MICROPIPETTES

- MEH6RF/SF is designed primarily for use with the Model 900A Micropressure System.
- EHB1 is for use in electrode beveling.
- MEH3SW is for microtitration of chloride with a silver wire as the electrode and a solution of silver nitrate filling the holder.
- MPH models do not contain Ag/AgCl half-cells and are used for pressure injection of substances through microelectrodes.
- PicoNozzle, used for pressure injection with PV800 Series PicoPumps, includes an MPH6S holder, which may also be used to couple a micropipette to a syringe.

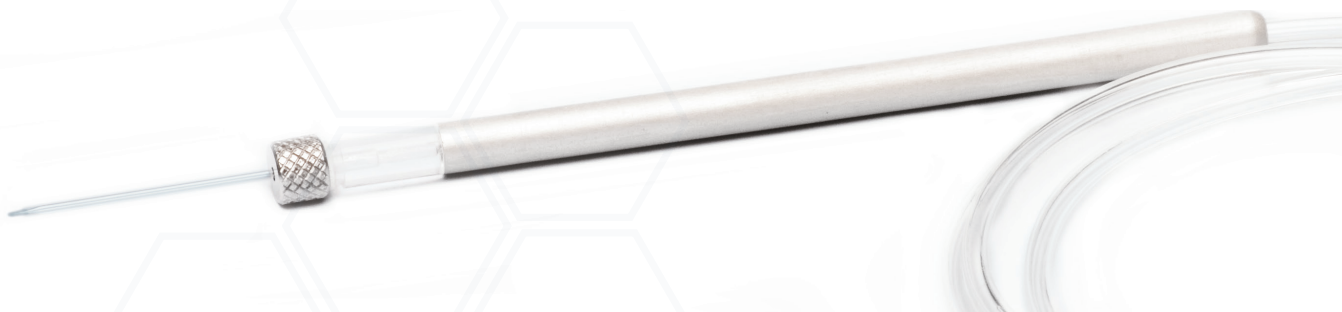

MICROELECTRODE HOLDERS

◆ = custom order (call for price)

Order Number Replace XX with glass OD *	Custom Order	Electric Connection Angle	Connector	Half-Cell	Pressure Port	Screw Cap	Designed for WPI Products
EHBF		Straight	Female	Wire	No Port	N/A	MBS, 48000
FOIMPH		Straight	Fiber Optic	None	No Port	w/Cap	MBS, 48000
MEH1Sxx		Straight	Male	Pellet	No Port	No Cap	
MEH1SFxx		Straight	Female	Pellet	No Port	No Cap	705, 773, 767, 721, FD223
MEH2Rxx	◆	Right	Male	Pellet	Male Luer	w/Cap	
MEH2RFxx	◆	Right	Female	Pellet	Male Luer	w/Cap	705, 773, 767, 721, FD223
MEH2RFWxx	◆	Right	Female	Wire	Male Luer	w/Cap	705, 773, 767, 721, FD223
MEH2RWxx	◆	Right	Male	Wire	Male Luer	w/Cap	
MEH2Sxx		Straight	Male	Pellet	Male Luer	w/Cap	
MEH2SFxx		Straight	Female	Pellet	Male Luer	w/Cap	705, 773, 767, 721, FD223
MEH2SFWxx	◆	Straight	Female	Wire	Male Luer	w/Cap	705, 773, 767, 721, FD223
MEH2SWxx		Straight	Male	Wire	Male Luer	w/Cap	
MEH345xx		45°	Male	Pellet	No Port	w/Cap	
MEH3F45xx	◆	45°	Female	Pellet	No Port	w/Cap	705, 773, 767, 721, FD223
MEH3FW45xx	◆	45°	Female	Wire	Port	w/Cap	
MEH3Rxx		Right	Male	Pellet	No Port	w/Cap	
MEH3RFxx		Right	Female	Pellet	No Port	w/Cap	705, 773, 767, 721, FD223
MEH3RFWxx	◆	Right	Female	Wire	No Port	w/Cap	705, 773, 767, 721, FD223
MEH3RWxx	◆	Right	Male	Wire	No Port	w/Cap	
MEH3Sxx		Straight	Male	Pellet	No Port	w/Cap	
MEH3SBWxx	◆	Straight	Banana	Wire	No Port	w/Cap	ISO-80, ISO-DAM8A
MEH3SFxx		Straight	Female	Pellet	No Port	w/Cap	705, 773, 767, 721, FD223
MEH3FWxx		Straight	Female	Wire	No Port	w/Cap	705, 773, 767, 721, FD223
MEH3SWxx		Straight	Male	Wire	No Port	w/Cap	
MEH3W45xx	◆	45°	Male	Wire	No Port	w/Cap	705, 773, 767, 721, FD223
MEH6RFxx		Right	Female	Pellet	2.0-mm Port	w/Cap	705, 773, 767, 721, FD223
MEH6RFWxx	◆	Right	Female	Wire	2.0-mm Port	w/Cap	705, 773, 767, 721, FD223
MEH6SFxx		Straight	Female	Pellet	2.0-mm Port	w/Cap	705, 773, 767, 721, FD223
MEH6FWxx	◆	Straight	Female	Wire	2.0-mm Port	w/Cap	705, 773, 767, 721, FD223
MEH7xx		Right	Male	Pellet	2.0-mm Port	w/Cap	
MEH7Wxx	◆	Right	Male	Wire	2.0-mm Port	w/Cap	
MEH8xx		Right	Male	Pellet	No Port	w/Cap	
MEH900Rxx		Right	Male	Pellet	2.0-mm Port	w/Cap	900A
MEH900Sxx		Straight	Male	Pellet	2.0-mm Port	w/Cap	900A
MPH1xx		—	None	None	Female Luer	w/Cap	
MPH3xx		—	None	None	Male Luer	w/Cap	
MPH4xx		—	None	None	2.0-mm Port	w/Cap	
MPH6Pxx	◆	Right	Male	Pellet	Female Luer	w/Cap	Piconozzle Kit (5430-XX)
MPH6Rxx	◆	Right	Male	Wire	Female Luer	w/Cap	Piconozzle Kit (5430-XX)
MPH6Sxx		—	None	None	Female Luer	w/Cap	Piconozzle Kit (5430-XX)

* Specify O.D. of glass (1.0, 1.2, 1.5 or 2.0 mm) by replacing XX in the Order Number with 10, 12, 15 or 20.

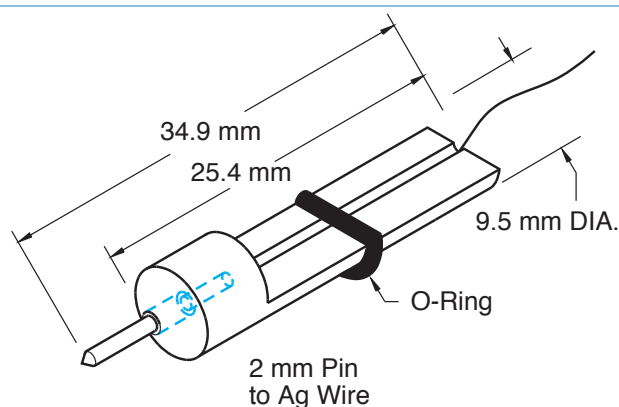
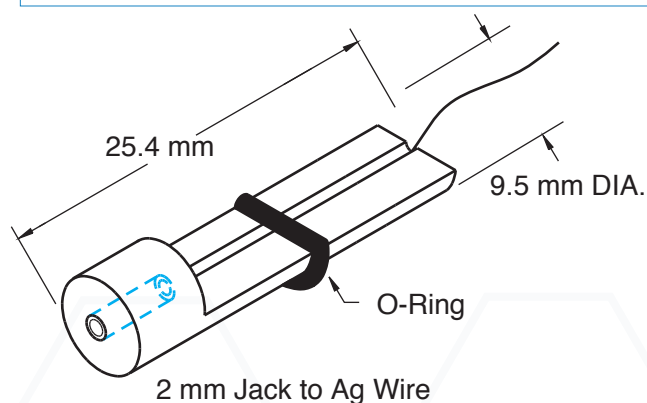

WORLD PRECISION INSTRUMENTS

UK: www.wpi-europe.com

Germany: www.wpi-europe.com

China: www.wpiinc.net

NANOFIL™ MICROLITER SYRINGE

NanoFil is a custom-designed syringe created for better microinjection in mice and other small animals. It is much easier and more accurate than any other method currently in use for quantitative nanoliter injection. It is available in 10 μ L (**NanoFil**) and 100 μ L (**NanoFil-100**) sizes.

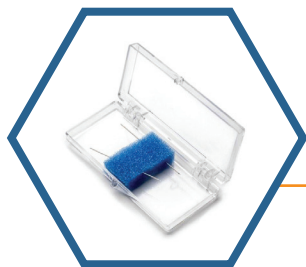

26G BEVELED REPLACEMENT NANOFIL NEEDLES

- NF26BV-2



NANOFIL APPLICATION KITS

- Beveled (**IO-KIT**)
- Blunt (**RPE-KIT**)



NANOFIL INJECTION HOLDER

- NFINHLD

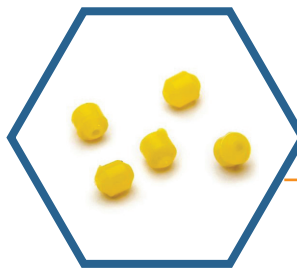

SPARE SILICONE GASKET FOR NANOFIL & HOLDER

- NFGSK-5

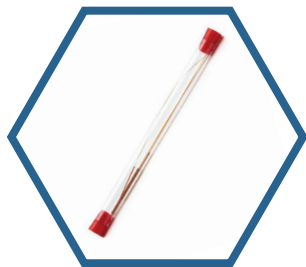

34G FLEXIBLE QUARTZ TUBING FOR FILLING

- NFQ34-5

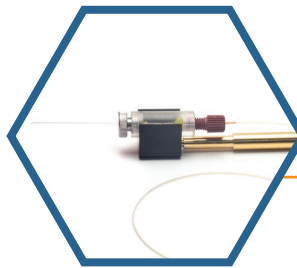

1.0 MM GLASS PIPETTE HOLDER FOR NANOFIL SYRINGE NANOFIL & HOLDER

- NFINHLD-G10

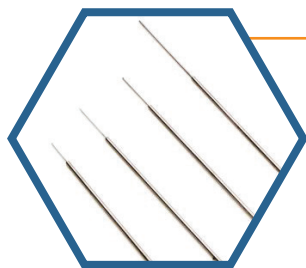

NANOFIL NEEDLES

- Beveled, 33-36G (**NF33-36BV**)
- Beveled, 33G (**NF33BV-2**)
- Beveled, 34G (**NF34BV-2**)
- Beveled, 35G (**NF35BV-2**)
- Beveled, 36G (**NF36BV-2**)
- Blunt, 33-36G (**NF33-36BL**)
- Blunt, 33G (**NF33BL-2**)
- Blunt, 34G (**NF34BL-2**)
- Blunt, 35G (**NF35BL-2**)
- Blunt, 36G (**NF36BL-2**)

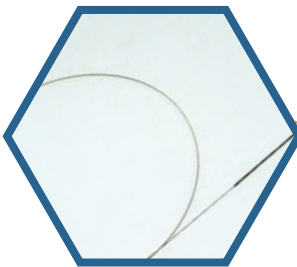

SILFLEX TUBING

- SILFLEX-2

FLUORODISH™ CELL CULTURES DISHES

Better imaging quality is provided by WPI's optical quality glass bottom FluoroDish Cell Culture dishes.

- Small sample volumes for expensive chemicals or experimental drugs.
- Smallest access angle to allow for easier insertion of a micropipette during cellular microinjection.
- Ideal for live cell imaging and embryo research.
- Optical grade, glass bottom dishes for clear images.
- Cited in hundreds of reference articles.

BOTTOM IS AS THIN AS A COVER SLIP

Our cell culture dishes have optical-grade glass bottoms that are the thickness of a coverslip (0.17 mm \pm 0.01 mm thick), providing better imaging quality. This allows for a much shorter working distance and the use of immersion objectives for the highest magnification possible. This glass has an exceptional UV transmission rate of 30% (at 300 nm). The UV transmission rate of the most popular German glass is less than 7%. Because our FluoroDish glass bottoms have a larger numerical aperture, you can use a higher magnification (up to 100X). The images you produce will differ depending on whether you use classical or fluorescent microscopy.

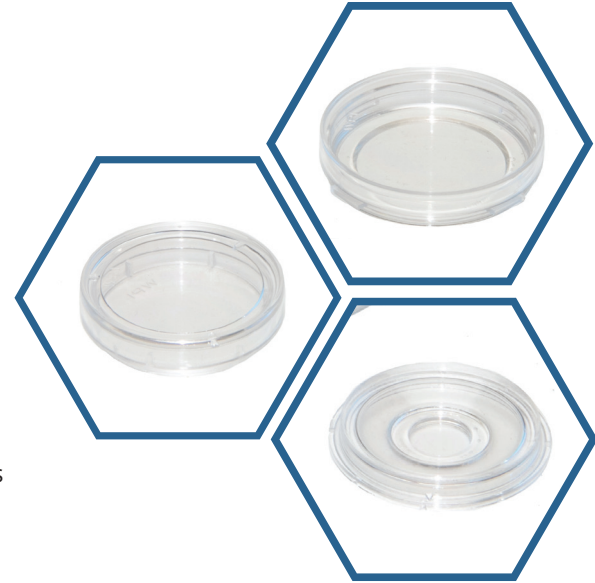

LOW SAMPLE VOLUMES

These dishes are ideal when using expensive drugs or chemicals due to their low sample volume. Only 115 μ L is required to cover the bottom well of our FD3510 Fluorodish with a 10 mm well! Try our FD5040 50 mm cell culture dishes for large growth areas. There are several sizes available, so you can select the best one for your needs. You can even get these dishes with a Poly-D-Lysine coating, which aids in neuron adhesion.

DESIGNED FOR RESEARCH

The culture dishes' slim side walls provide a low access angle, allowing for greater flexibility in microelectrode placement. For low background fluorescent measurements, black wall dishes are available. To ensure the viability of your cell cultures, culture dishes are made with a low toxicity adhesive.



**HIGH RESOLUTION
IMAGING**

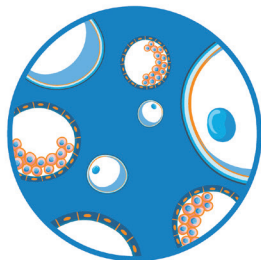

**LIVE CELL
IMAGING**

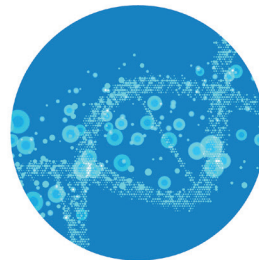

**ELECTROPHYSIOLOGY RECORDING
OF FLUORESCENT TAGGED CELLS**

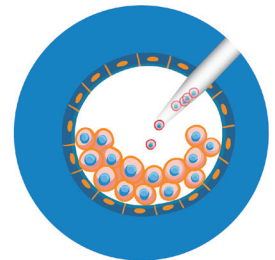

MICROINJECTION



FD35-100

- FluoroDish Cell Culture Dish
- 35mm Diameter
- 23mm Well

FD3510-100

- Poly-D-Lysine Coated

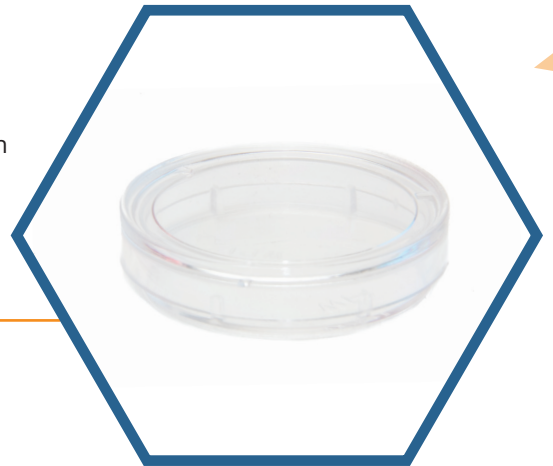

FD5040-100

- FluoroDish Cell Culture Dish
- 50mm Well

FD3510-100

- FluoroDish Cell Culture Dish
- 35mm Diameter
- 10mm Well

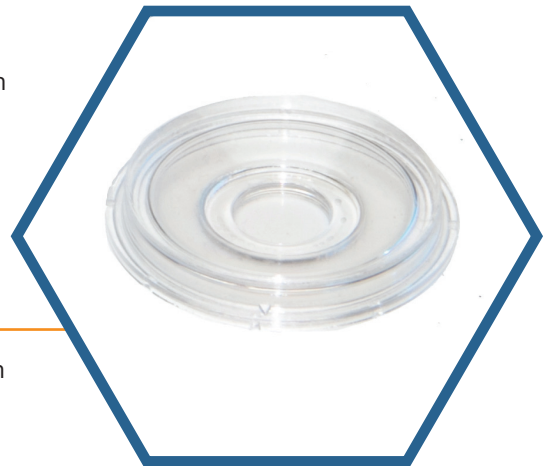

STANDARD FLUORODISHES

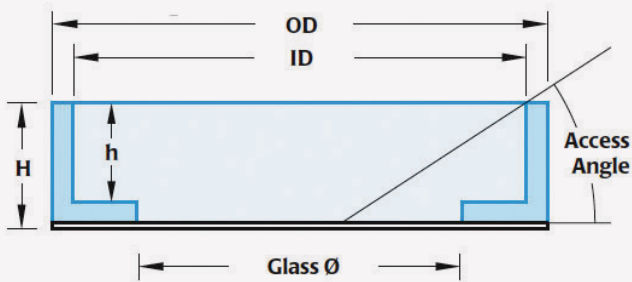

Style	ID (mm)	OD (mm)	Glass Ø (mm)	Height (inside)	Height (outside)	Access Angle
FD35	33	35.5	23.5	7.8	9	29
FD5040	47.5	49.82	35	7.25	7.4	17

LOW VOLUME FLUORODISHES (FD3510)

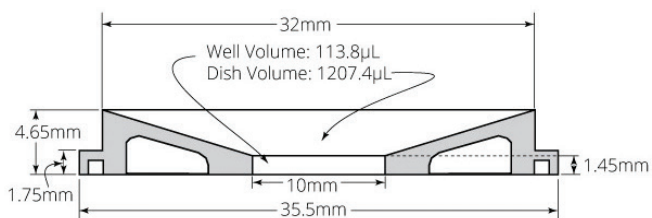

CENTRIFUGES

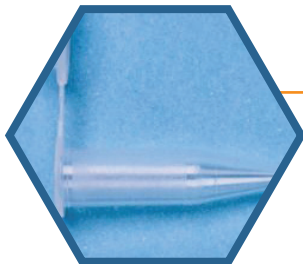

MICROCENTRIFUGE TUBES

- 0.5mL (503529)
- Natural 1.5mL (503530)
- Pkg of 1000



MINI CENTRIFUGE, BLUE LID, 2 ROTORS, 110V

- 504321
- 9 position Microtube Rotor
- Storage Compartment for PCR Rotor
- Quiet Operation
- Starts and Stops in Seconds



MICROCENTRIFUGE TUBES 2.0ML

- 503531
- 2.0mL
- Pkg of 1000



MINI CENTRIFUGE, PURPLE LID, 2 ROTORS, 240V

- 504328
- 8 Position Microtube Rotor
- Storage Compartment for PCR Rotor
- Quiet Operation
- Starts and Stops in Seconds



MICROCENTRIFUGE TUBE STRIPS 0.2ML

- Domed Cap Strips (503532)
- Flat Cap Strips Included (503537)
- Pkg of 250



MICRO-CENTRIFUGE

- G-SPIN6
- Small Size with Rubber Feet Keeps the Centrifuge Stable
- Interchangeable Rotors and Adapters for 0.5-2.0mL Microtubes or PCR Strips
- On/Off Switch Lets You Start and Stop in Seconds
- Safety Switch Stops Rotor



MICRO-CENTRIFUGE, 220V

- G-SPIN6-220
- Simple, Precise, and Durable
- 5 Micrometer Resolution
- Engineered for Stability and Built on a 12-pound Steel Plate
- For Direct Table Top Use

HOTPLATE

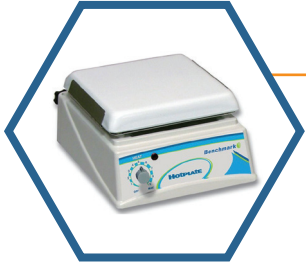

HOTPLATE, 115V

- 504312
- CE Certified
- Ceramic Work Surface, 7.5 x 7.5 Inches
- Temperature Control Up to 380°C

CIRCULATING WATER BATH, 5L



- 115 V (505060)
- 230 V (505062)
- Stainless Steel Bath Tank
- Temperature Accuracy $\pm 0.03^{\circ}\text{C}$
- 60 Hz Heat Only

STERILIZERS AND AUTOCLAVES



STERI-LITE GLASS BEAD STERILIZER

- 150 g/US (ST5191)
- 300 g/US (ST5193)
- Available with International Power Supplies



BENCHTOP AUTOCLAVE, 16 LITER

- 110 V US Plug (ST5189)
- 230 V Euro Plug (ST5189-EU)
- 16 L Tank
- Dimensions 56 x 44.5 x 40cm (21x17.5x15.7")
- Tray Dimensions 16.5 x 27 cm (6.5x10.75")
- Weight 40kg (89 lbs)

WATER BATHS



CIRCULATING WATER BATH, 13L

- 115 V (505061)
- 230 V (505063)
- Stainless Steel Bath Tank
- Temperature Accuracy $\pm 0.03^{\circ}\text{C}$
- 60 Hz Heat Only

SYRINGE PUMPS

ALADDIN PUMPS



- Aladdin Single-Syringe Infusion Pump
 - 2 AL-1000 Pumps (AL-2000)
 - Infuse Only (AL-300)
 - Standard (AL-1000)
- Programmable Double Syringe Pump (AL-4000)
- Multi-Barrel Programmable 6 Syringe Pump (AL-6000)
- Multi Programmable Syringe Pump (AL-8000)

LEGATO PROGRAMMABLE PUMPS

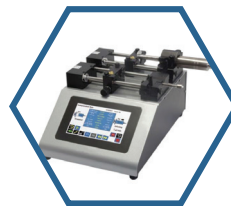

- Dual Rate Syringe Pump (SPLG-G88PLUS)
- SPLG Syringe Pump with Touchscreen
 - Dual Infuse Only (SPLG101)
 - Infuse Only (SPLG100)
 - Infuse/Withdrawl (SPLG110)
- SPLG Syringe Pump
 - Infuse Only (SPLG200)
 - Infuse/Withdrawl (SPLG210)
 - Programmable Infuse/Withdrawl (SPLG212)
 - Programmable Push-pull (SPLG272)
 - Push-pull (SPLG270)
- Adagio Software/USB Key (504578)

OTHER LAB SUPPLIES

- MICRO-PROCESSOR CONTROLLED SYRINGE PUMPS
- THERMOMETERS
- STANDS AND CLAMPS
- SPECIALTY WIRE (PLATINUM IRIIDIUM, TUNGSTEN, TIN, SILVER, GOLD, TITANIUM, AND CARBON)
- POWER SUPPLIES.
- CONNECTORS AND ADAPTERS
- CABLES
- RACKMOUNTS
- LIGHT SOURCES FOR MICROSCOPES
- MICROSCOPE CAMERAS
- CAMERA ACCESSORIES, CABLES & MOUNTS
- MICROSCOPE SLIDES
- MISCELLANEOUS LAB SUPPLIES (DEMAGNETIZER, AGAROSE, SCREWDRIVERS AND MORE)
- ABSORBENT PAPER POINTS
- KITS
- STUDENT INSTRUMENTS
- VASCULAR CATHETERS
- EAR PUNCHES AND TAGS
- BIOPSY PUNCHES
- RODENT BRAIN MATRICES

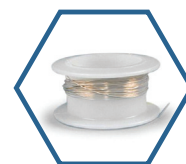
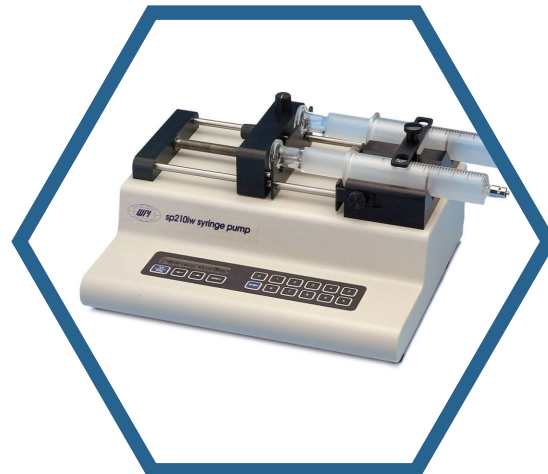



WORLD
PRECISION
INSTRUMENTS

Register at:
www.wpiinc.com/newlab



WORLD PRECISION INSTRUMENTS

United States: (866) 606-1974 · wpi@wpiinc.com · www.wpiinc.com Germany: +49 (0)30 61 88845 · wpide@wpi-europe.com · www.wpi-europe.com
UK: +44 (0)1462 424700 · wpiuk@wpi-europe.com · www.wpi-europe.com China: +86 21 6888 5517 · chinasales@china.wpiinc.com · www.wpiinc.net

DISCLAIMER: Offers cannot be combined with other promotions and are subject to change. Offers valid in the USA only. Offer valid for new labs.